

Keeping Keeping

Food Food Food

Hot Hot Hot Hot

Since Since Since

1986 1986 1986

Quality

above

all else.

Welcome to the world of Stayhot.

We manufacture functional, elegant & reliable food warming products that stand the test of time. We strive to achieve the very highest standard & quality in everything we create.

To ensure this, our strip heaters & heat lamps are manufactured with precision in our Swedish factory.

We combine our own production with a carefully curated range of products from trusted partners throughout Europe and beyond.

A family owned business with over 30 years experience in the industry, we aim to continue the legacy of providing high quality products for demanding kitchens long into the future.



Karl Lobelius
CEO, Stayhot AB



Heat



Our Stayhot Heat Lamp Classic are built by hand in our Swedish warehouse, using high quality anodised aluminum.

Lamp



Classic





Stayhot Heat Lamp Classic

Manufactured in our Swedish warehouse, the Stayhot Classic heat lamps are available in several models, as fixed length or with a rise and fall function. All our models are all available in aluminum, brass, copper and black.

Product Information

Shade	H 350mm / Ø 180mm
Material	Anodised Aluminum
Power	230 V / 250 W

Made by



We strive to achieve the very highest standard & quality in all products we create.

hand in

To ensure this, our strip heaters & heat lamps are manufactured with precision in our Swedish factory.



Sweden.

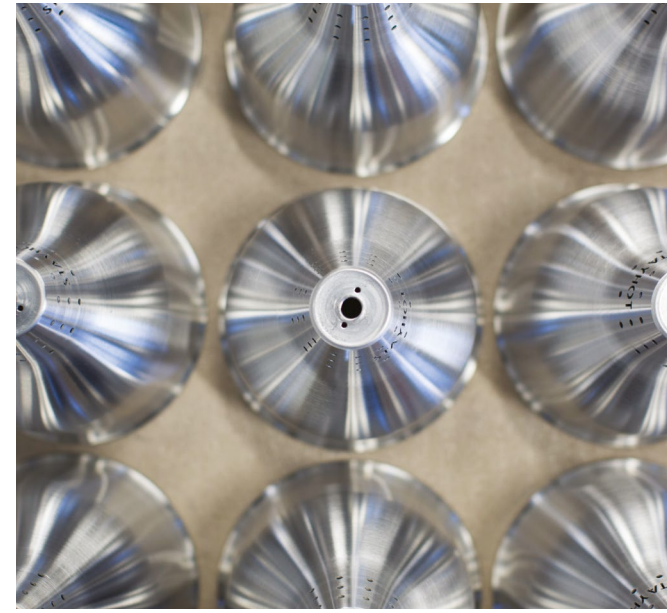

Heat



Stayhot Focus Heat Lamps are made for the kitchens of tomorrow, blending timeless design with components of the highest quality.

Lamp

Designed and developed by our innovation team, each lamp is built by hand in our Swedish factory, using high quality anodised aluminum.



Focus



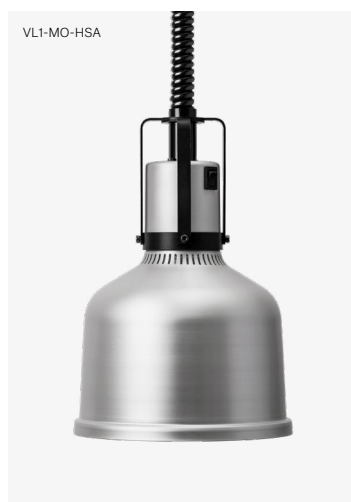
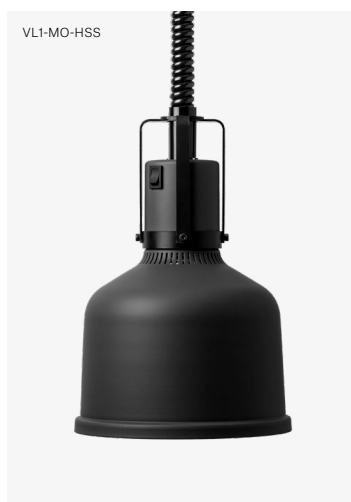
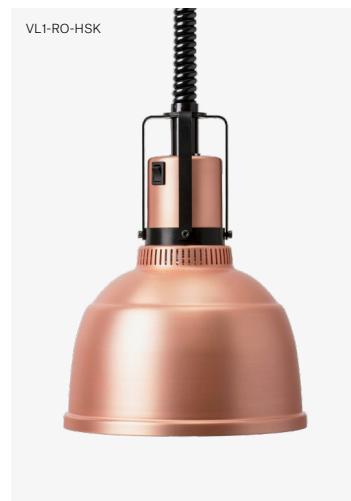
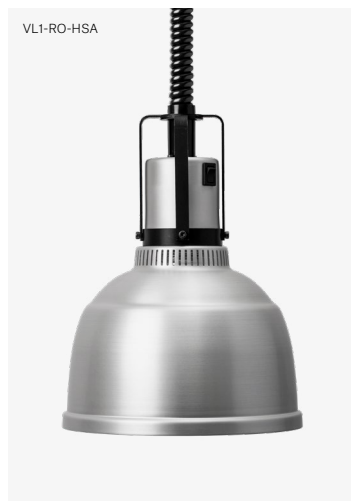

Stayhot Heat Lamp Focus

Our brand new series — Stayhot Focus — has been designed, developed and manufactured in our Swedish warehouse. Available in several models, as fixed length and with a rise and fall function.

Product Information

Shade	H 250mm / Ø 200 - 220 mm
Material	Anodised Aluminum
Power	230 V / 250 W

Stayhot

Manufactured with high quality stainless steel in our factory in Stockholm, our Strip Heaters are built to last & perform in all type of kitchens.

Strip

Available in four different lengths, with or without lights. Locally manufactured, our strip heaters come with adjustable fastening ends. Table stand or chains for hanging are available as add-ons.

Heaters



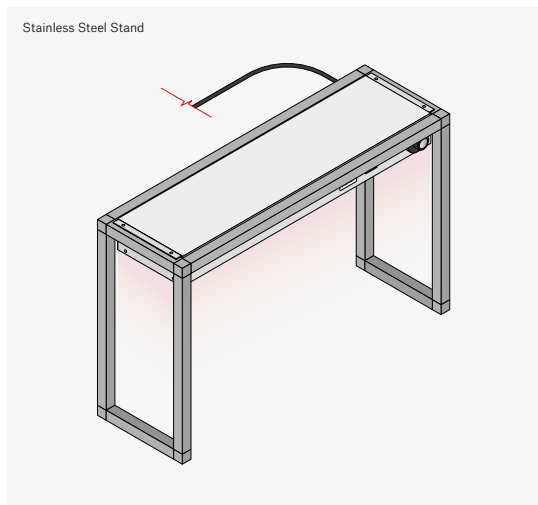

Stayhot Strip Heaters

Our quality strip heaters comes in four lengths and are available with or without lights.

Locally manufactured, they come with adjustable fastening ends. Table stand or chains for hanging are available as add-ons.

Product Information

Material	Stainless steel
Heat Source	Quartz heating element
Installation	30-40 cm above the food
Measurements	570 - 1430 mm x 150 x 60 mm
Voltage	230 V
Power	575 - 1050 W

Staychill

Chill

Trays

Sometimes you just need to keep cool & calm. For these moments, we have our Staychill™ Chill Trays, available in five gastronorm sizes. They will keep your food appetizingly fresh, & most importantly, cold.





Staychill™ Chill Trays

Whether it is for the breakfast buffet or the salad buffet, Staychill™ is the effective solution for keeping food cold.

Our Chill Trays keep anything from sandwiches to butter cold, whilst being an excellent helper for holiday buffets as well as any cold cut smorgasbord.

Product Information

Instructions	Put the Staychill Chill Tray in the freezer overnight (+12 hours). It will maintain a temperature below +8 °C for at least 3 hours.
Material	Aluminum



Hot &



The StayHot&Cold combo plates offer extreme cold (-5 °C) to searing heat (-140 °C), all in the same product! With such versatile features, it's perfect for the ever-changing restaurant buffet.

Cold

Manufactured in Austria, we are the exclusive dealer of the StayHot&Cold combo plates in all of Scandinavia & the Baltics.



Plates



Combo Plate GN 1/1



Combo Plate GN 2/1



Combo Plate GN 3/1



Combo Plate Round



Freestanding
Hot Plate GN 1/1



Freestanding
Combo Plate GN 1/1

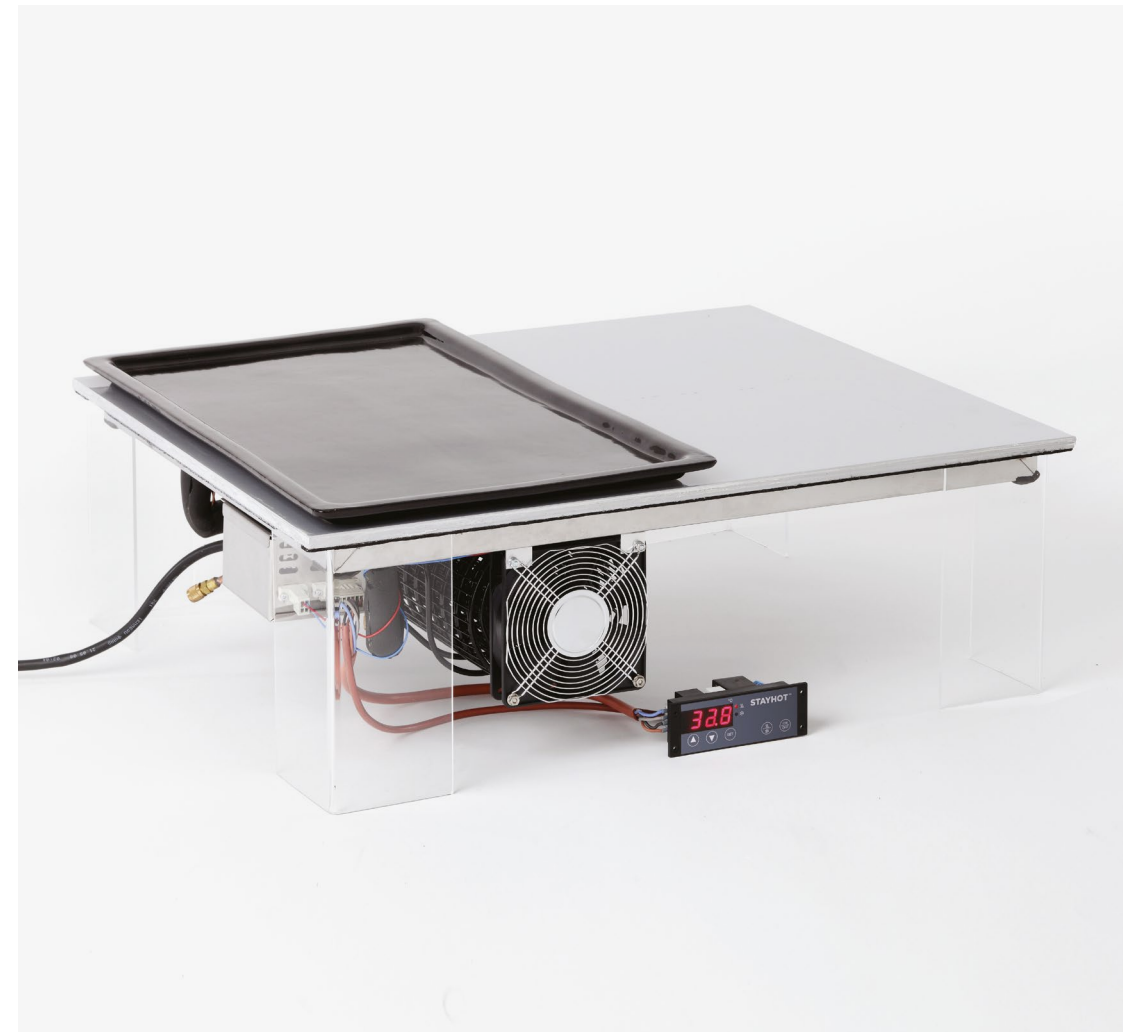

StayHot&Cold Combo Plates

StayHot&Cold offers chill trays, hot trays and our revolutionary combo plates, offering extreme cold to searing heat, all in the same product!

Choose between a durable stainless steel top or the elegant but tough Gorilla Glass, available in four various RAL colours.

We also offer freestanding models as well as combo wells.

Product Information

Material	6,9 mm multi-layer material CNS / Aluminum / CNS
Optional	Glass Coating 2 mm
Voltage	240 V
Power	850 – 2340 W (GN 1/1 – 3/1)
Accessories	1 m controller cable 2 m power supply
Requirements	Supply- and exhaust air must be ensured

Stayhot



Our high quality hot trays are a great addition to any restaurant buffet. Manufactured with ceramic glass, our hot trays are functional, elegant & affordable.

Hot

Available as flexible freestanding units with or without variable controls, is complemented with our latest model — WPE 307 — an elegant recess option for the more permanent buffet solution.

Plates



StayHot&Cold Combo Plates

Our effective Stayhot hot trays are perfect for the food buffet. Manufactured with components from the leading manufacturer of ceramic glass in Europe. Models also available with infinitely variable temperature via thermostat from 40 °C to 105 °C.

Product Information

Material	Ceramic glass
Heat Source	Foil elements
Power	230 V

info@stayhot.se

EMAIL

www.stayhot.se

WEBSITE

+46 8 35 79 15

PHONE NUMBER

Knistavägen 1B

OFFICE

191 62 Sollentuna